

**36** Kg/24h

Machines à glaçons à aspersion / Spray Ice Makers:  
C28 - C28+ - C38 - C46 - C54 - C70 - C90  
C28 F - C28+ F - C38 F - C46 F - C54 F - C70 F - C90 F

C38 F

230V/1N/50Hz  
**GLAÇONS PLEINS**

- USB
- BLUETOOTH
- WI-FI
- TOUCH CONTROL
- RAINBOW TECHNOLOGY
- SAFE ICE
- PROGRAMMED OZONE CYCLE
- SCHEDULED PRODUCTION

## CARACTÉRISTIQUES

- Construction en acier inox
- Version à air ou à eau
- Cycle de nettoyage
- Panneau de contrôle touch
- Alarme acoustique et lumineuse
- Report alarmes HACCP
- Réglage du poids du glaçon
- Réglage du niveau de la glace du réservoir
- Clé USB pour mise à jour logicielle et téléchargement des données HACCP
- Analytique prédictive des dysfonctionnements
- Report des performances



## TYPE GLACE / ICE TYPE

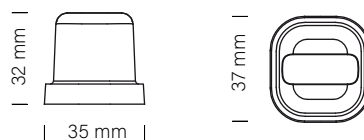

PCS / CYCLE

**28**

POIDS DU GLAÇONS  
ICE WEIGHT

**20 g**

PRODUCTION GLACE /  
ICE PRODUCTION

**kg/24h**  
*lbs/24h*

## OPTIONS

- Kit pieds
- Désinfection à l'Ozone
- Rainbow Technologie traitement évaporateur
- Pompe de vidange externe

Condensation à Air  
Air Cooled Unit



Temp. Air Air Temp.	Temp. Eau / Water Temp.			
	°C	32° 90°	21° 70°	15° 60°
10°	<b>30</b>	<b>34</b>	<b>36</b>	<b>38</b>
50°	66	75	79	84
21°	<b>27</b>	<b>30</b>	<b>32</b>	<b>34</b>
70°	60	66	71	75
32°	<b>23</b>	<b>26</b>	<b>28</b>	<b>30</b>
90°	57	57	62	66
38°	<b>19</b>	<b>21</b>	<b>22</b>	<b>23</b>
100°	42	46	49	51

## FEATURES

- Stainless steel construction
- Air or water condensation
- Sanitization cycle
- Programmable ice production
- Capacitive button
- Acoustic and luminous alarms
- Report HACCP alarms
- Cube weight adjustment
- Storage bin ice level adjustment
- USB connection for software update and HACCP data download
- Condenser fan controlled at low ambient temperatures
- Predictive analysis of malfunctions
- Machine performance report.

## CAPACITÉ STOCKAGE / BIN CAPACITY

**11,5 kg**

**575 pcs**

## DIMENSIONS

L x P x H (mm)



400 x 540 x 690



460 x 600 x 850

## VOLTAGE



220-240/50/1  
220/60/1

## GAS



R290  
GWP=3  
Ton CO2 equiv. = 0

Condensation à Eau  
Water Cooled Unit



Temp. Air Air Temp.	Temp. Eau / Water Temp.			
	°C	32° 90°	21° 70°	15° 60°
10°	<b>28</b>	<b>32</b>	<b>34</b>	<b>36</b>
50°	62	71	75	79
21°	<b>26</b>	<b>30</b>	<b>32</b>	<b>34</b>
70°	57	66	71	75
32°	<b>25</b>	<b>29</b>	<b>31</b>	<b>33</b>
90°	55	64	68	73
38°	<b>21</b>	<b>26</b>	<b>28</b>	<b>29</b>
100°	46	57	62	64

## DONNÉES TECHNIQUES / TECHNICAL DATA

	cond	comp. W	ABS. W	Fuse	Kwh/100Kg	l / h	kg	kg	
C38 A AG	220-240/50/1		670	370	10	29.0	3.2	34	40
C38 W AG	220-240/50/1		670	290	10	20.3	43.2	34	40

Via del Lavoro, 9 31033 Castelfranco Veneto (TV) Tel.  
+39 0423.738452 Fax +39 0423.722811  
email: info@castelmac.it  
www.castelmac.eu - www.icematic.eu

**36** Kg/24h

Machines à glaçons à aspersion / Spray Ice Makers:  
C28 - C28+ - C38 - C46 - C54 - C70 - C90  
C28 F - C28+ F - C38 F - C46 F - C54 F - C70 F - C90 F

C38 F

230V/1N/50Hz  
**GLAÇONS PLEINS**

## DIMENSIONS

Vue frontale  
Front view

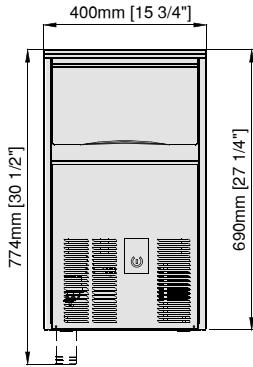

Vue latérale  
Side view

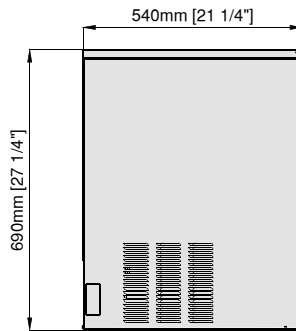

Vista de dessus  
Top view

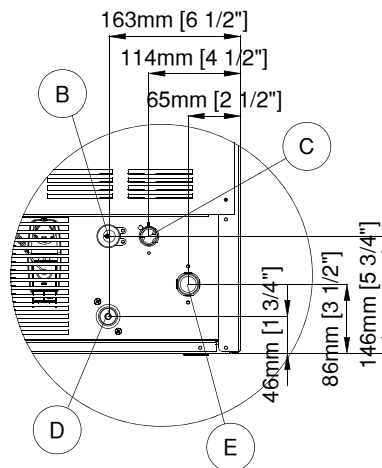
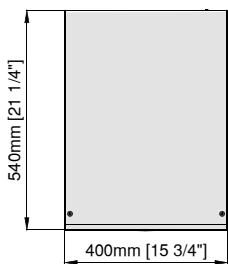

- B** Alimentation électrique / Electrical cable supply
- C** Drainage de l'eau Ø 20 mm / Water outlet connection Ø 20 mm
- D** Sortie de l'eau condensation à eau Ø20mm / Water outlet connection water condensation Ø20mm
- E** Entrée de l'eau 3/4" gas / Water inlet connection 3/4" gas

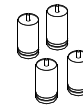

Kit 4 Pieds  
Kit 4 Feet  
Ø50mm H100-120 mm  
**(Opzionali-optional)**

## TOUCH CONTROL

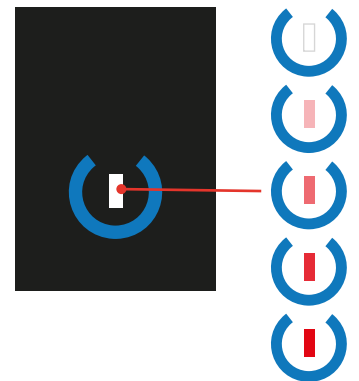

Bouton Capacitif de réinitialisation Stand-by  
(led à variation continue de couleurs du blanc au rouge)

Capacitive Stand-by Reset button  
(led with continuous colors variation from white to red)

## APP MyICE

Permet de contrôler et de gérer la machine à glaçons à distance, directement sur le smartphone / It allows the control and monitoring of the ice machines directly from a smartphone

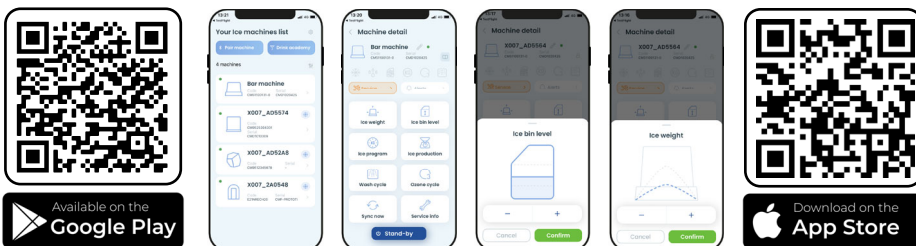

## CONDITIONS DE TRAVAIL - OPERATING REQUIREMENTS

	Min.	Max
Témp. Ambiante / Air Temperature	10°C	40°C
Témp. Eau / Water Temperature	5°C	35°C
Press. eau / Water Pressure	1 Bar (14psi)	5 Bar (70psi)
Conductivité eau / Water conductivity	-- µS	-- µS
Voltage / Electrical supply	-10%	+10%

Chaleur expulsé / Rejected Heat	979 W
Volume Air / Air Volume	185 m³/h

Via del Lavoro, 9 31033 Castelfranco Veneto (TV) Tel.  
+39 0423.738452 Fax +39 0423.722811  
email: info@castelmac.it  
www.castelmac.eu - www.icematic.eu