



## Product specification

### Technical data

**Table 1: Electrical specifications**

|                                    |                    |
|------------------------------------|--------------------|
| Contact load (Alternating current) | 0.5 A, 250 V, AC15 |
|                                    | 12 W, 125 V, DC 13 |
| Switch                             | SPDT               |

**Table 2: Environmental conditions**

|                      |   |
|----------------------|---|
| Ambient temperature  | -40 – 70 °C   |
| Shock resistance     | 50 g/6 ms   |
|                      | Acc. to EN 60068-2-27                                     |
| Vibration resistance | Free fall acc. to EN 60068-2-32                           |
|                      | Sin 4 g, 5Hz – 200 Hz acc. to EN 60068-2-6 <sup>(1)</sup> |
| Enclosure            | IP65 to EN 60529  |
|                      | Anodized AlMgSi 1, AW-6082 T6                             |

<sup>(1)</sup> If higher vibrations are present in the system/installation, temperature controls with capillary tube or armoured capillary tube are recommended.

**Table 3: Mechanical characteristics**

|                       |                                      |
|-----------------------|--------------------------------------|
| Electrical connection | DIN 43650 plug, Pg 9, Pg 11, Pg 13.5 |
|-----------------------|--------------------------------------|

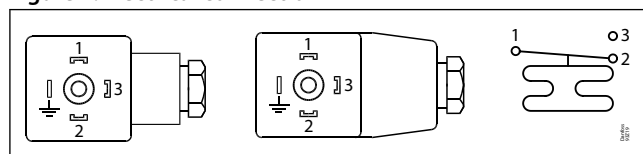
**Figure 1: Electrical connection**

|   |  |
|---|--|
| 1 | Input                                      |
| 2 | Output: Normally closed (NC)               |
| 3 | Output: Normally open (NO)                 |
| ⏏ | Connected to enclosure of pressure control |

### Standard specification and code numbers

**Table 4: Standard specification and code numbers**

| Setting range | Fixed diff. | Max. sensor temp. | Cap. tube length | Capillary tube |               | Armoured capillary tube |               | Sensor pocket | Rigid sensor |               |
|---------------|-------------|-------------------|------------------|----------------|---------------|-------------------------|---------------|---------------|--------------|---------------|
|               |             |                   |                  | Code no.       | Type MBC 8100 | Code no.                | Type MBC 8100 |               | Code no.     | Type MBC 8100 |
| -10 – 30      | 3           | 80                | 2                | 061B820166     | 1221-1A02000  | 061B810166              | 1231-1A02000  | –             | –            | –             |
| 20 – 60       | 3           | 130               | 2                | –              | –             | 061B810266              | 1431-1A02000  | –             | –            | –             |
| 20 – 60       | 3           | 130               | –                | –              | –             | –                       | –             | 75            | 061B800266   | 1411-1A00075  |
| 50 – 100      | 4           | 200               | 2                | 061B820366     | 2221-1A02000  | 061B810366              | 2231-1A02000  | –             | –            | –             |
| 50 – 100      | 4           | 200               | –                | –              | –             | –                       | –             | 75            | 061B800366   | 2211-1A00075  |
| 70 – 120      | 5           | 220               | 2                | –              | –             | 061B810466              | 2431-1A02000  | –             | –            | –             |
| 70 – 120      | 5           | 220               | –                | –              | –             | –                       | –             | 75            | 061B800466   | 2411-1A00075  |
| 60 – 150      | 6           | 250               | 2                | 061B820566     | 2621-1A02000  | 061B810566              | 2631-1A02000  | –             | –            | –             |
| 60 – 150      | 6           | 250               | –                | –              | –             | –                       | –             | 75            | 061B800566   | 2611-1A00075  |

## Setting point correction

The sensor on MBC 8100 thermostat contains an adsorption charge. Therefore its function is not affected whether the sensor is placed warmer or colder than the remaining part of the thermostatic element (bellows and capillary tube). However, such a charge is to some extent sensitive to changes in the temperature of the bellows and capillary tube. Under normal conditions this is of no importance, but if the thermostat is to be used in extreme ambient temperatures the setting point might change.

The deviation can be compensated for as follows:

Setting point correction = Z x a

Z can be found from **Figure 2: Setting point correction**, while **a** is the correction factor from the table below.

Figure 2: Setting point correction

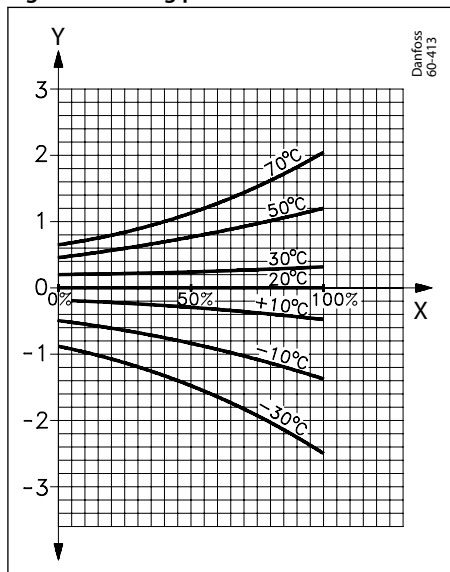

|   |                                    |
|---|------------------------------------|
| X | Relative scale setting in [%]      |
| Y | Factor for setting point deviation |

Table 5: Correction factor

| Regulation range [°C] | Correction factor a for thermostats |                               |
|-----------------------|-------------------------------------|-------------------------------|
|                       | with rigid sensor                   | with 2 and 5 m capillary tube |
| -10 – 30              | –                                   | 1.1                           |
| 20 – 50               | 1.0                                 | 1.4                           |
| 50 – 100              | 1.5                                 | 2.2                           |
| 70 – 120              | 1.7                                 | 2.4                           |
| 60 – 150              | –                                   | 3.7                           |

### Example:

A MBC 8100 with capillary tube length 2 m and range 50 – 100 °C must cut out at 75 °C in 70 °C ambient temperature. At which cut out temperature should this temperature control be set at in 20 °C ambient temperature.

The relative setting **Z** can be calculated from the following formula:

$$\frac{\text{Setting value} - \text{min. range}}{\text{max. range} - \text{min. range}} \times 100\%$$

$$\text{Relative setting: } \frac{75 - 50}{100 - 50} \times 100 = 50\%$$

### Relative setting:

Factor for setting point deviation **Z**, see **Figure 2: Setting point correction**.

Z - 1.2

Correction factor **a** (table under fig. 1) a = 2.2

Setting point correction Z x a = 1.2. x 2.2 = 2.6 °C

**The MBC must be set at 75 + 2.6 = 77.6 °C in 20 °C ambient temperature in order to cut out at 75 °C ambient temperature.**

## Installation

### Installation

MBC thermostats are designed to withstand the shocks that occur, e.g. in ships, on compressors and in large machine installations. MBC thermostats with remote sensor are fitted with 5 mm screws to bulkheads or similar. See [Figure 3](#). MBC thermostats with rigid sensor are self-supporting from the sensor pocket. For permissible media pressure, see [Figure 4](#).

Figure 3: Mounting example

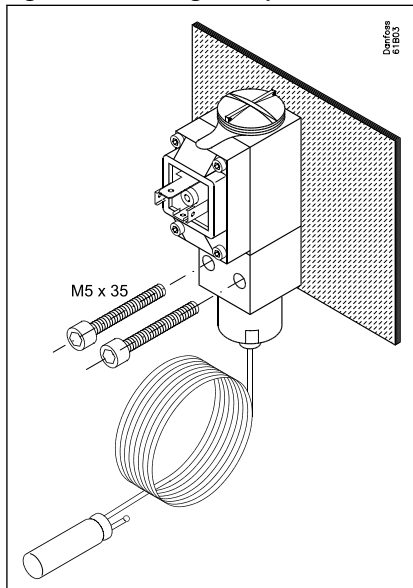
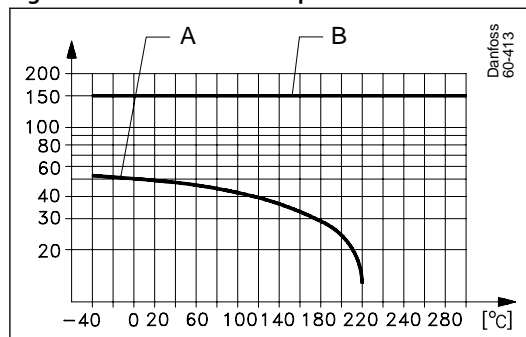

Figure 4: Permissible media pressure on the sensor pocket as a function of temperature



|          |                 |
|----------|-----------------|
| <b>A</b> | Brass           |
| <b>B</b> | Stainless steel |

### Resistance to media

Material specifications for sensor pockets:

#### Sensor pocket, brass

The tube is made of CuZn30, CW 505L acc. to EN 12449, the threaded portion of CuZn39 Pb3, CW 614N acc. to EN 12164.

#### Sensor pocket, stainless steel 18/8

Material designation X5CrNi18-10, 1.4301 acc. to EN 10088.

### Sensor position

As far as possible the sensor should be positioned so that its longitudinal axis is at right angles to the direction of flow. The active part of the sensor is  $\varnothing 13$  mm x 50 mm long on thermostat with rigid sensors and 2 m capillary tube.

### Setting

When the top cover screw at the thermostat is removed, the range can be set with the setting screw. The differential is non-adjustable.

Figure 5: Adjustment

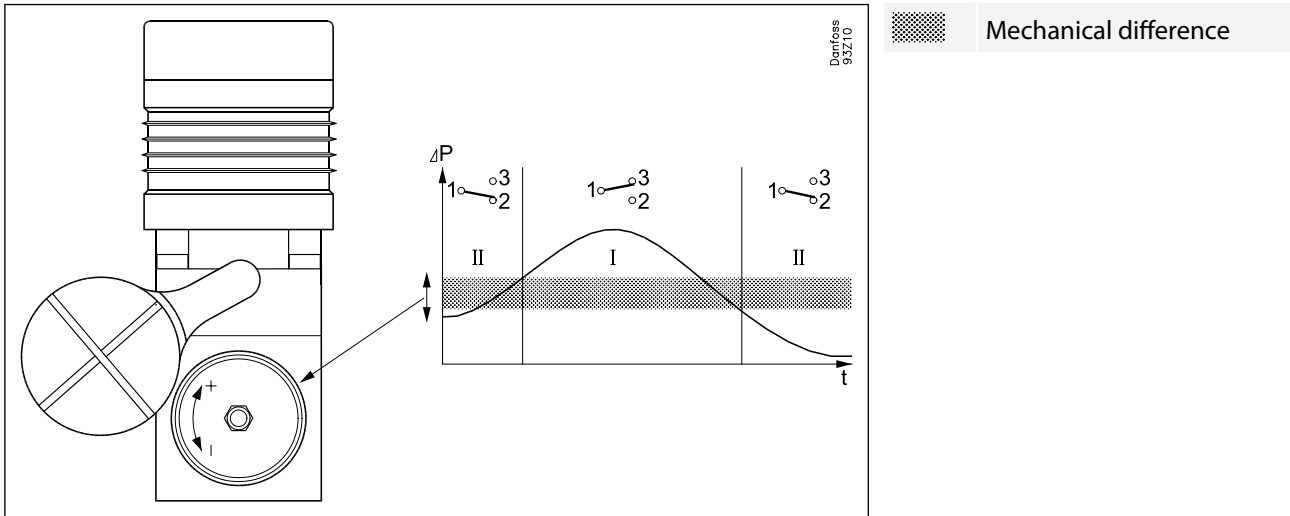

**Dimensions and weights**

Table 6: Dimensions [mm] and weights [kg]

| Rigid sensor     |  | Cap. tube version |  |
|------------------|--|-------------------|--|
|                  |  |                   |  |
| Net weight: 0.25 |  | Net weight: 0.27  |  |

## Ordering

Figure 6: Ordering of customized types

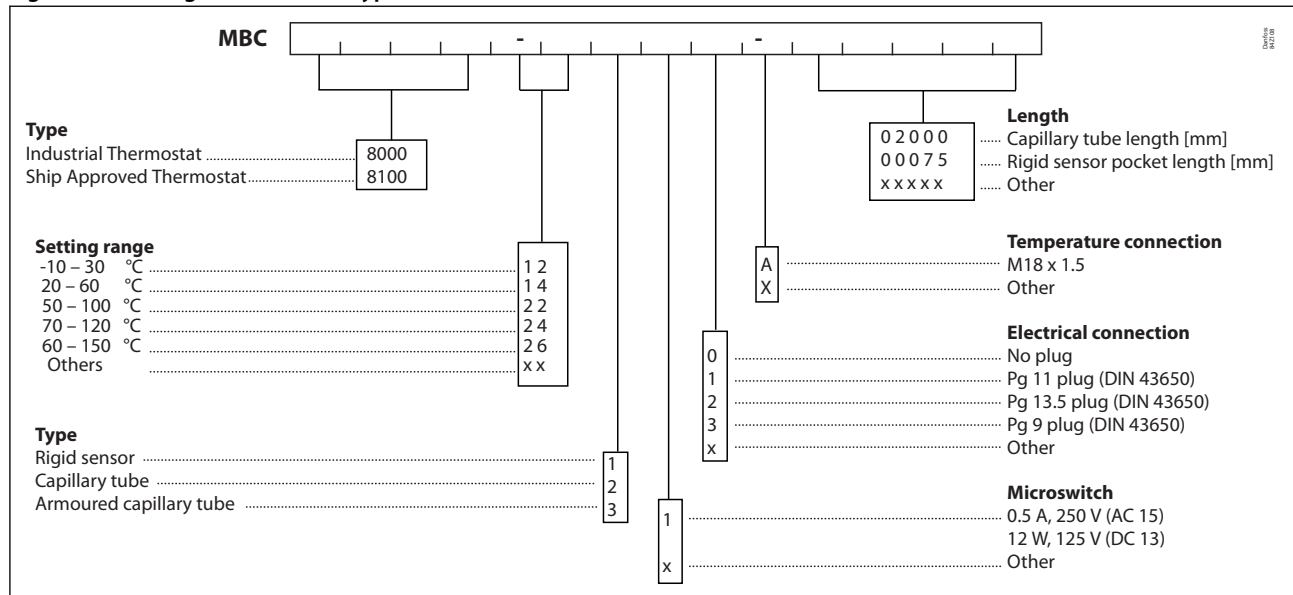



## Accessories

Table 7: Sensor pockets

| Part  | Sensor pocket | A [mm] | Thread B            | Code no.   |
|---|---------------|--------|---------------------|------------|
| <p>Supplied without gland nut, gaskets and washer</p> | Brass         | 75     | 1/2 NPT             | 060L326466 |
|   |               | 75     | G 1/2 A             | 060L326266 |
|   |               | 75     | G 3/4 A             | 060L326666 |
|   |               | 75     | G 1/2 A (ISO 228-1) | 060L328166 |
|   | Brass         | 110    | 1/2 NPT             | 060L328066 |
|   |               | 110    | G 1/2 A             | 060L327166 |
|   |               | 110    | G 3/4 A (ISO 228-1) | 060L340366 |
|   | Brass         | 160    | G 1/2 A             | 060L326366 |
|   | Steel 18/8    | 75     | G 1/2 A             | 060L326766 |
|   | Steel 18/8    | 110    | G 1/2 A             | 060L326866 |
|   |               |        | 1/2 NPT             | 060L327066 |
|   | Steel 18/8    | 160    | G 1/2 A             | 060L326966 |

## Thermostat, Type MBC 8000 and MBC 8100

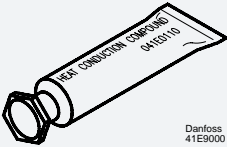
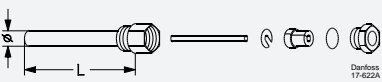
Table 8: Other parts

| Part  | Description   | Code no.   |
|---|---|------------|
| <b>Clamping band</b><br>                       | For MBC thermostats with remote sensor (L = 392 mm)   | 017-420466 |
| <b>Heat-conductive compound (6 g tube)</b><br> | For MBC thermostats with sensor fitted in a sensor pocket. Compound for filling sensor pocket to improve heat transfer between pocket and sensor. Application range for compound: -20 – 150 °C, momentarily up to 220 °C. | 041E0115   |
| <b>Gasket set</b><br>                          | For MBC thermostats without armoured capillary tubes  | 060L327366 |
| <b>Gasket set</b><br>                          | For MBC thermostats with armoured capillary tubes   | 060L036666 |

## Certificates, declarations, and approvals

The list contains all certificates, declarations, and approvals for this product type. Individual code number may have some or all of these approvals, and certain local approvals may not appear on the list.

Some approvals may change over time. You can check the most current status at [danfoss.com](http://danfoss.com) or contact your local Danfoss representative if you have any questions.

**Table 9: MBC 8000**

| File name           | Document type                   | Document topic | Approval authority |
|---------------------|---------------------------------|----------------|--------------------|
| 2003010305069847    | Electrical - Safety Certificate | -              | CCC                |
| EU 060-9680.AA      | EU Declaration                  | LVD            | Danfoss            |
| UA.10146.D.00075-19 | UA Declaration                  | EMCD/LVD       | LLC CDC EURO TYSK  |
| 060-9639.AB         | Manufacturers Declaration       | China RoHS     | Danfoss            |
| 2020970305003455    | CCC Declaration                 | -              | Danfoss            |

**Table 10: MBC 8100**

| File name           | Document type                   | Document topic | Approval authority |
|---------------------|---------------------------------|----------------|--------------------|
| 17.20389.258        | Marine - Safety Certificate     |                | RMRS               |
| HMB 17529-AE001     | Marine - Safety Certificate     |                | KR                 |
| 14-20046(E1)        | Marine - Safety Certificate     |                | LR                 |
| GB19PTB00011_05     | Marine - Safety Certificate     |                | CCS                |
| TAA00002BB          | Marine - Safety Certificate     |                | DNV GL             |
| TA20287M            | Marine - Safety Certificate     |                | NKK                |
| 16-LD1581072-PDA    | Marine - Safety Certificate     |                | ABS                |
| 11676-D1 BV         | Marine - Safety Certificate     |                | BV                 |
| ELE-364617XG        | Marine - Safety Certificate     |                | RINA               |
| 060-9680.AA         | EU Declaration                  | LVD            | Danfoss            |
| 2003010305069847    | Electrical - Safety Certificate |                | CCC                |
| UA.10146.D.00075-19 | UA Declaration                  | EMCD/LVD       | LLC CDC EURO TYSK  |
| 060-9639.AB         | Manufacturers Declaration       | China RoHS     | Danfoss            |
| 2020970305003455    | CCC Declaration                 |                | Danfoss            |

CE-marked in accordance with:

- LVD 2014/35/EU (EN 60947-1, EN 60947-4-1, EN 60947-5-1)



## Online support

Danfoss offers a wide range of support along with our products, including digital product information, software, mobile apps, and expert guidance. See the possibilities below.

### The Danfoss Product Store



The Danfoss Product Store is your one-stop shop for everything product related—no matter where you are in the world or what area of the cooling industry you work in. Get quick access to essential information like product specs, code numbers, technical documentation, certifications, accessories, and more.

Start browsing at [store.danfoss.com](https://store.danfoss.com).

### Find technical documentation



Find the technical documentation you need to get your project up and running. Get direct access to our official collection of data sheets, certificates and declarations, manuals and guides, 3D models and drawings, case stories, brochures, and much more.

Start searching now at [www.danfoss.com/en/service-and-support/documentation](https://www.danfoss.com/en/service-and-support/documentation).

### Danfoss Learning



Danfoss Learning is a free online learning platform. It features courses and materials specifically designed to help engineers, installers, service technicians, and wholesalers better understand the products, applications, industry topics, and trends that will help you do your job better.

Create your Danfoss Learning account for free at [www.danfoss.com/en/service-and-support/learning](https://www.danfoss.com/en/service-and-support/learning).

### Get local information and support



Local Danfoss websites are the main sources for help and information about our company and products. Find product availability, get the latest regional news, or connect with a nearby expert—all in your own language.

Find your local Danfoss website here: [www.danfoss.com/en/choose-region](https://www.danfoss.com/en/choose-region).

---

#### Danfoss A/S

Climate Solutions • [danfoss.com](https://danfoss.com) • +45 7488 2222

Any information, including, but not limited to information on selection of product, its application or use, product design, weight, dimensions, capacity or any other technical data in product manuals, catalogues descriptions, advertisements, etc. and whether made available in writing, orally, electronically, online or via download, shall be considered informative, and is only binding if and to the extent, explicit reference is made in a quotation or order confirmation. Danfoss cannot accept any responsibility for possible errors in catalogues, brochures, videos and other material. Danfoss reserves the right to alter its products without notice. This also applies to products ordered but not delivered provided that such alterations can be made without changes to form, fit or function of the product.

All trademarks in this material are property of Danfoss A/S or Danfoss group companies. Danfoss and the Danfoss logo are trademarks of Danfoss A/S. All rights reserved.