

Data Sheet

RA 2000 Series RA 15/6T & TB Conversion Valve

Applications:



RA15/6T

Internal bypass allowing for series piping to the radiators/baseboards. This series piping provides continuous flow but the supply water temperature will decrease.

RA15/6TB

A conventional two-pipe system where each radiator/baseboard is supplied. A traditional supply and return manifold can be utilized.

With the installation of the RA 15/6T and TB valves any RA2000 thermostatic operator or TWA electronic actuator can be mounted, providing individual temperature regulation and controlled comfort for the room.

The RA 15/6T and TB is a special conversion valve that allows a single connection point-at the side of the radiator- to serve as both the supply & return for a hot water based system. An example of its application is the transformation of a 1-pipe steam system into a hot water based system.

There are two versions to this valve:

Features:

- Compact design
- Minimized installation area
- Thermostatic operator or electric actuator control of valve
- Single entry valve connection to radiator
- Valve assembly for 1-pipe steam conversion to hot water
- Alternative method of piping for fin tube or baseboard addition

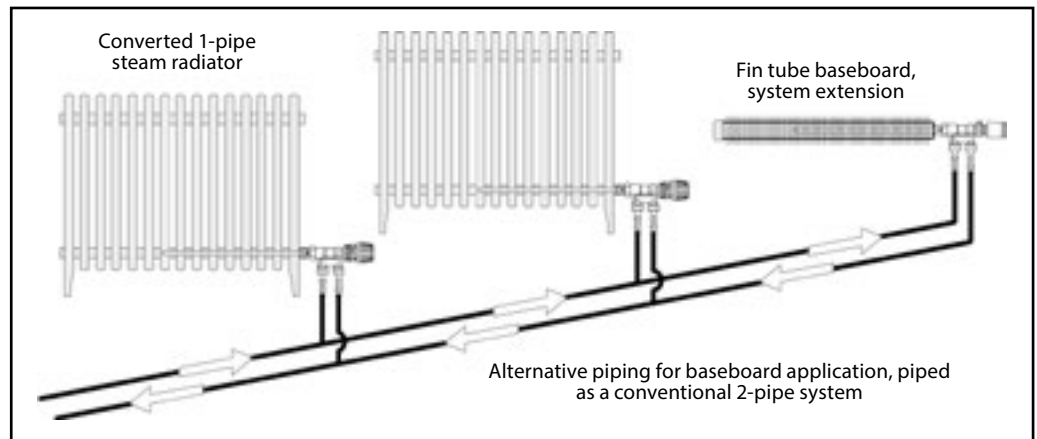

Applications (Cont.):

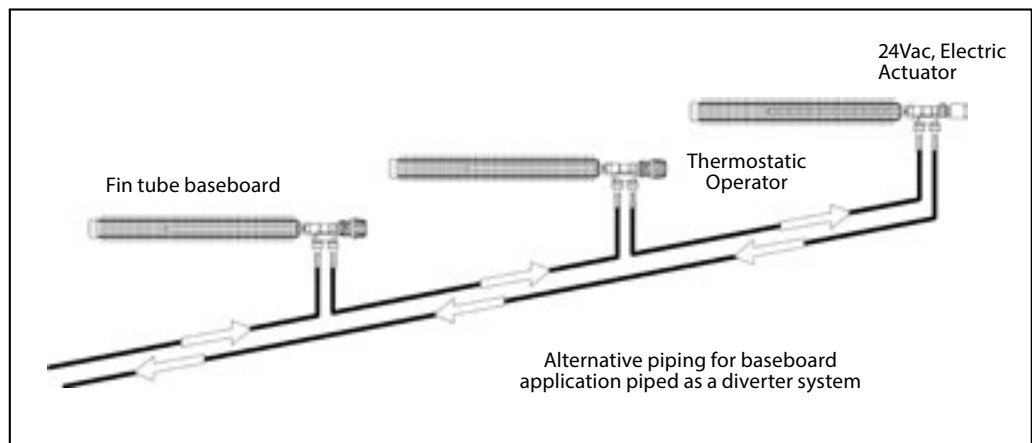
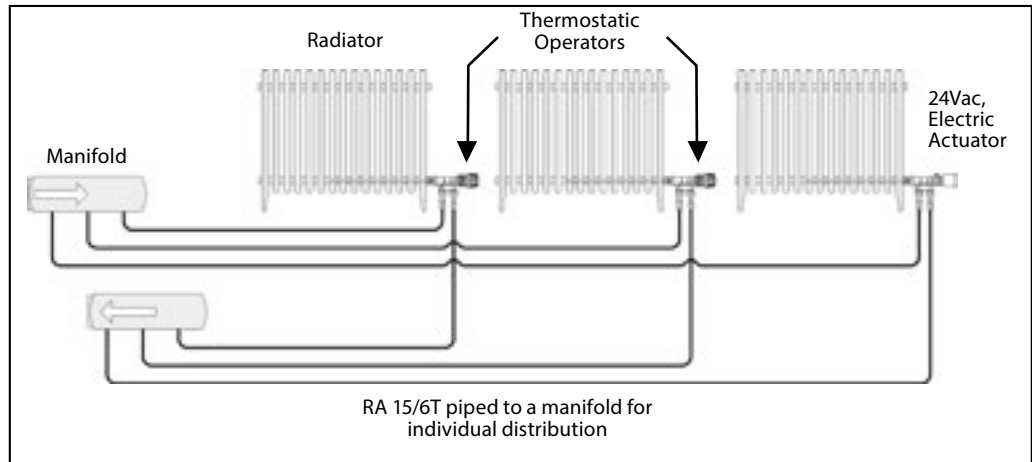







Ordering Information:







Valve	Code No.	Size	Model	Cv	Connection
	013G3270	1/2"	RA15/6T	2.34 ¹	Rp 1/2 int. thread ²
	013G3268				G 3/4 ext. thread ³
	013G3215		RA15/6TB	1.17	Rp 1/2 int. thread ²

¹ Cv = Cv bypass + Cv radiator. Max flow through radiator, approx. 35%.
² Rp 1/2 int. thread are straight thread, non-NPT thread.
³ G 3/4 ext. threading require fittings.



Fittings & Spare Parts:

Fittings	Code No.	Description
	013G4116	1/2" Copper compression fitting for RA 15/6T & TB, 2 pcs required, use with 013G3215 & 013G3270 only
	013U0476	1/2" M. NPT tailpiece for RA 15/6T, 2 pcs required, use with 013G3268 only
	013U8608	1/2" F. solder tailpiece for RA 15/6T, 2 pcs required, use with 013G3268 only
	013U0496	1/2" Union nut for RA 15/6T, 2 pcs required, use with 013G3268 only
Spare Parts	Code No.	Description
	013G0290	Packing gland
	013G1350	Angle Adaptor

RA2000 Thermostatic Operator:

Operator	Code No.	Description	Sensor	Capillary
	013G8250	Standard valve mounted dial and sensor	Built-in	-
	013G8252	Standard valve mounted dial with remote sensor	Remote	6'
	013G8240	Tamper resistance valve mounted dial and sensor	Built-in	-
	013G2922	Tamper resistant valve mounted dial with remote sensor	Remote	6'
	013G8562	Combined remote mounted dial and sensor	Built-in	6'
	013G8562			16'
	013G8562			26'
	013G8564	Seperate remote mounted dial and sensor	Remote	6' + 6'

Electronic Thermo-wax Actuators:

Actuator	Code No.	Type	Operation	Actuator Position
	088H3110	TWA-A actuator 24VAC, 2VA c/w valve position indicator	ON/OFF	NC
	088H3111			NO
	088H3114			NC, w/ end switch
	082F1091	ABNM actuator 24VAC, 1.5VA requires control signal	Proportional (0-10VDC)	NC

Specifications:

Suitable applications	1) 1-pipe steam conversion to hot water systems 2) Hot water fin tube or baseboard applications	
Max. working pressure	145 psi (10 bar)	
Max. differential pressure	8.7 psi (0.6 bar)	
Max. test pressure	232 psi (16 bar)	
Max. flow temperature	248 ° F (120 ° C)	
Connection	RA 15/6T	RA 15/6TB
	Rp 1/2 int. thread ¹	Rp 1/2 int. thread ¹
	G 3/4 ext. thread ²	

Design and Function:

The RA 15/6T and TB valves are a unique design assembly that offer control of radiators or fin tube baseboard through a thermostatic operator or electronic actuator control. The 1/2" connection to the radiator allows supply hot water to enter and through the same connection allows return water to leave. This circulation through the radiator is achieved through the 8" straight flow tube which is inserted into the radiator. The flow tube receives the return water, while hot water is delivered through the radiator connection. If the length of the radiator is long, the flow tube can be extended by soldering on a 1/4" copper tube to the end of the flow tube. The extension to the flow tube results in a pressure drop of 0.02 FOH/in. The extension will allow cooler water furthest from the connection to leave the radiator and be replaced by hot water.

The valve body is also an ideal alternative in the conversion of a one pipe steam system into a hot water system. In considering the conversion valve for a 1-pipe steam system, verify that across the top of the radiator are push nipples.

The push nipples located at the top of the radiator provides circulation for hot water within the radiator. Unfortunately, if the radiator lacks push nipples at the top, the effectiveness of the conversion valve is greatly reduced.

Prior to installation of the conversion valve, the potential 1-pipe steam radiator should be pressure tested to ensure it will be capable of handling the increased pressure from a hot water system. In addition the radiator should also be flushed to remove any debris from within that could potentially clog the valve or other components within the system.

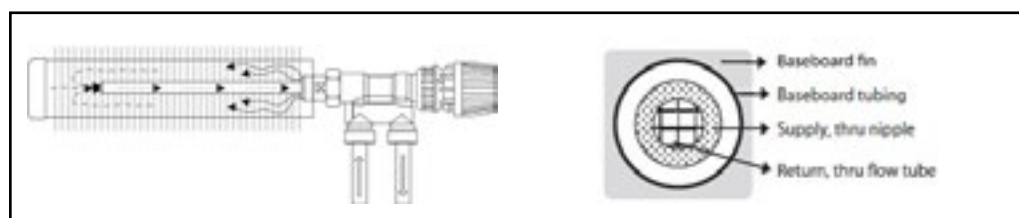

Design and Function (Cont.):

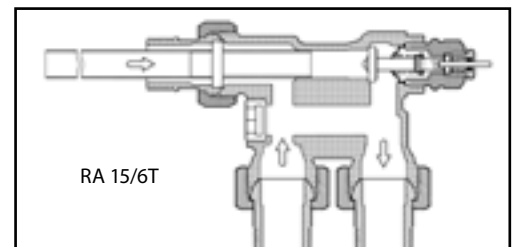
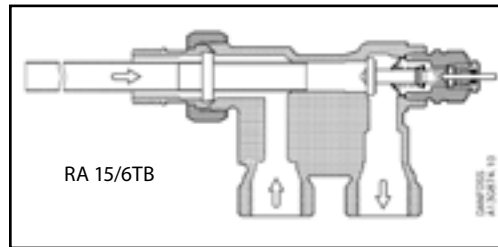

Construction:

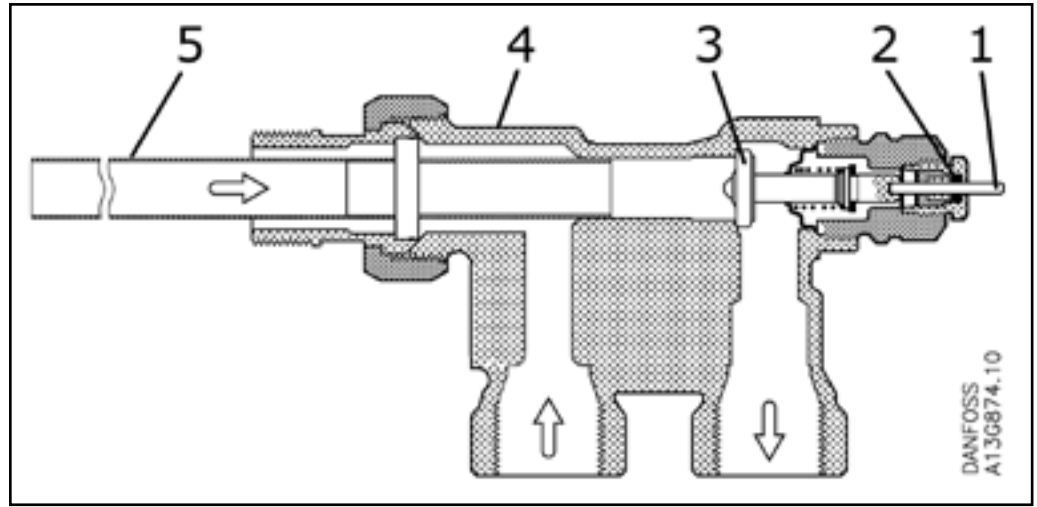

1- Pressure pin
2- O-ring gland seal
3- Valve cone
4- Valve body
5- Flow tube

Materials in contact with water

Pipe supporting bushing	PP
O-ring	EPDM
Valve cone	NBR rubber
Pressure pin	Chrome steel
Lock washer	Tin alloy
Valve body and other metal parts	Ms 58 brass

Dimensions inches (mm):

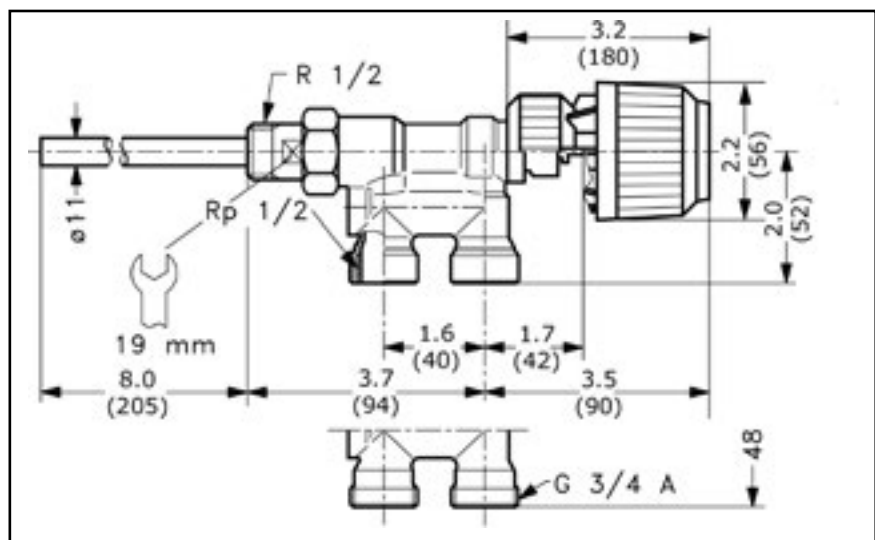

Typical Specification:

The valve shall be nickel plated and capable of delivering supply hot water and receiving return water through a single connection to the radiator. An incorporated flow tube shall receive the return from the radiator and be capable of extending its length. The valve shall be used on a closed loop water based system and have the option of a bypass function. The mountable control for the valve shall have the option of either a

non-electric thermostatic operator or a 24V electric actuator. The thermostatic operator shall be available in either a valve or wall mounted dial operator. The valve mounted dial shall be a vapor charged operator and installed via snap-action mechanism or Allen key. The brass valve body shall have a packing gland assembly capable of replacement while the system is in operation.

Danfoss can accept no responsibility for possible errors in printed materials and reserves the right to alter its products without notice. All trademarks in this material are property of the respective companies. Danfoss and Danfoss logotype are trademarks of Danfoss A/S. All rights reserved.



Danfoss Inc.
Toronto, ON
Toll Free: 866-375-HVAC (4822)
Tel.: 905-285-2050, Fax: 905-285-2055
www.na.heating.danfoss.com

Danfoss Inc.
Baltimore, MD
Toll Free: 866-375-HVAC (4822)
Tel.: 443-512-0266, Fax: 443-512-0270
www.na.heating.danfoss.com