

TL5CN LBP/MBP Compressor R290 220-240V 50Hz

General

Code number	102H4590
Approvals	EN 60335-2-34
Compressors on pallet	125

Application

Application	LBP/MBP		
Frequency	Hz	50	60
Evaporating temperature	°C	-40 to 5	-
Voltage range	V	198 - 254	-
Max. condensing temperature continuous (short)	°C	55 (65)	-
Max. winding temperature continuous (short)	°C	125 (135)	-

Cooling requirements

Frequency	Hz	50			60		
Application		LBP	MBP	HBP	LBP	MBP	HBP
32°C		F ₁	F ₁	-	-	-	-
38°C		F ₁	F ₁	-	-	-	-
43°C		F ₁	F ₁	-	-	-	-
Remarks on application:		Run capacitor 4 µF compulsory in 43°C ambient temperature at MBP conditions.					

Motor

Motor type	RSIR/RSCR/CSIR		
LRA (rated after 4 sec. UL984), HST LST	A	5.7	5.4
Cut in Current, HST LST	A	5.7	9.7
Resistance, main start winding (25°C)	Ω	14.5	14.8

Design

Displacement	cm ³	5.08
Oil quantity (type)	cm ³	280 (polyolester)
Maximum refrigerant charge	g	150
Free gas volume in compressor	cm ³	1690
Weight without electrical equipment	kg	7.5

Dimensions

Height	mm	A	173
		B	169
		B1	-
		B2	-
Suction connector	location/I.D. mm angle	C	6.2 30°
	material comment		Copper Rubber plug
Process connector	location/I.D. mm angle	D	6.2 31.5°
	material comment		Copper Rubber plug
Discharge connector	location/I.D. mm angle	E	5.0 28°
	material comment		Copper Rubber plug
Oil cooler connector	location/I.D. mm angle	F	-
	material comment		-
Connector tolerance	I.D. mm		±0.09, on 5.0 +0.12/+0.20
Remarks:			

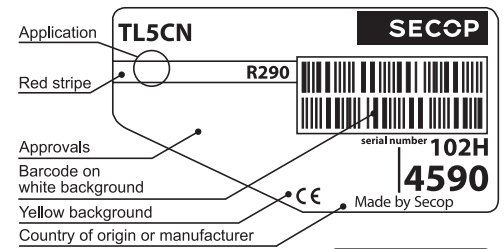

- S = Static cooling normally sufficient
- O = Oil cooling
- F₁ = Fan cooling 1.5 m/s (compressor compartment temperature equal to ambient temperature)
- F₂ = Fan cooling 3.0 m/s necessary
- SG = Suction gas cooling normally sufficient
- = not applicable in this area

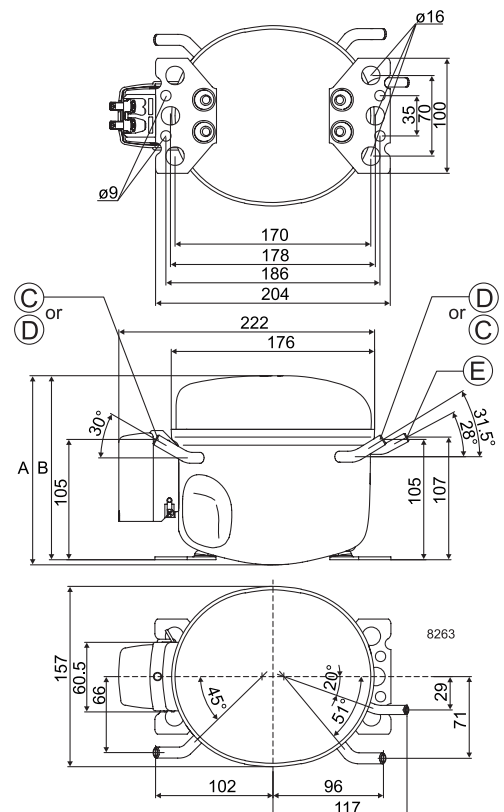

EN 12900 Household (CECOMAF)* 220V, 50Hz, 2 W PTC consumption incl., fan cooling F₁

Evap. temp. in °C	-45	-40	-35	-30	-25	-23.3	-20	-15	-10	-6.7	-5	0	5	7.2	10	15	20
Capacity in W		81	109	143	183	198	230	283	345	391	416	496	586				
Power cons. in W		113	130	146	162	167	178	194	211	222	228	247	266				
Current cons. in A		1.00	1.04	1.09	1.14	1.16	1.19	1.25	1.32	1.36	1.39	1.46	1.54				
COP in W/W		0.71	0.84	0.98	1.13	1.18	1.29	1.46	1.64	1.76	1.82	2.01	2.21				

ASHRAE LBP* 220V, 50Hz, 2 W PTC consumption incl., fan cooling F₁

Evap. temp. in °C	-45	-40	-35	-30	-25	-23.3	-20	-15	-10	-6.7	-5	0	5	7.2	10	15	20
Capacity in W		92	124	162	206	223	259	319	389	441	469	560	662				
Power cons. in W		114	130	145	161	166	176	192	208	219	225	243	262				
Current cons. in A		1.00	1.04	1.09	1.14	1.15	1.19	1.24	1.31	1.35	1.37	1.44	1.52				
COP in W/W		0.81	0.96	1.11	1.28	1.35	1.47	1.66	1.87	2.01	2.09	2.31	2.53				

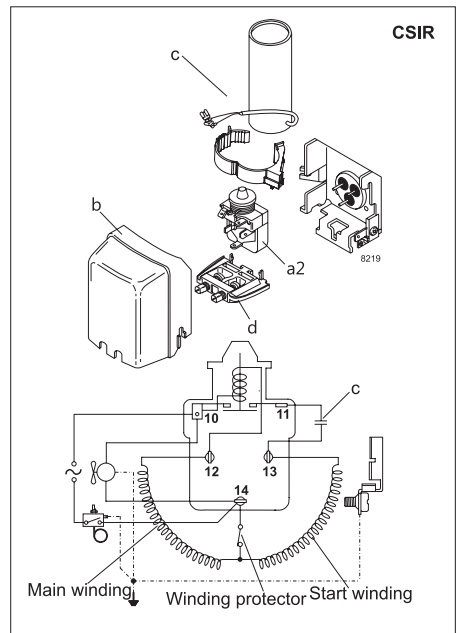
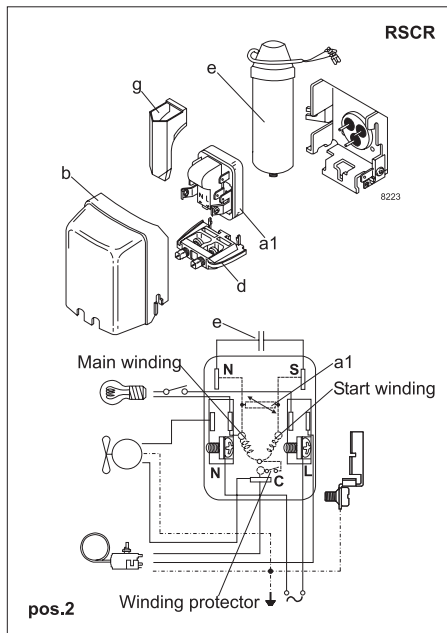
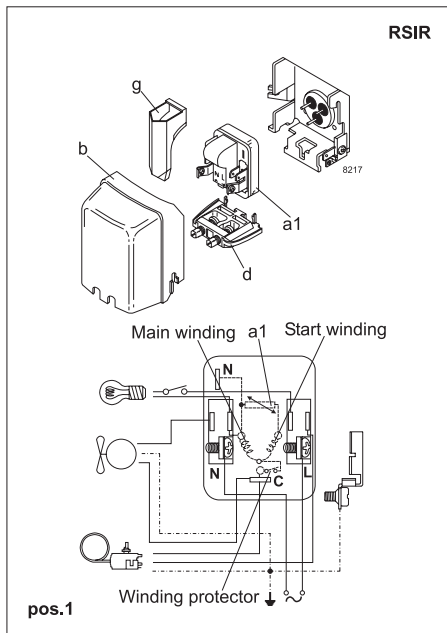

Accessories for	TL5CN	Figure	Code number
PTC starting device	6.3 mm spade connectors	a1	103N0011
	4.8 mm spade connectors	(pos.1)	103N0018
PTC starting device	6.3 mm spade connectors	a1	103N0016
	4.8 mm spade connectors	(pos.2)	103N0021
Starting relay	6.3 mm spade connectors	a2	117U7000
Start. capacitor 60 µF	6.3 mm spade connectors	c	117U5014
Cover		b	103N2010
Cord relief		d	103N1010
Run capacitor 4 µF (optional)	6.3 mm spade connectors	e	117-7117
	4.8 mm spade connectors	e	117-7119
Protection screen for PTC		g	103N0476

Test conditions	EN 12900/CECOMAF*	ASHRAE LBP*
Condensing temperature	45°C	43.3°C
Ambient temperature	32°C	32°C
Suction gas temperature	32°C	32°C
Liquid temperature	no subcooling	32°C

Mounting accessories	Code number	
Bolt joint for one comp.	Ø: 16 mm	118-1917
Bolt joint in quantities	Ø: 16 mm	118-1918
Snap-on in quantities	Ø: 16 mm	118-1919

Secop accepts no responsibility for possible errors in catalogs, brochures, and other printed material. Secop reserves the right to alter its products without notice. This also applies to products already on order provided that such alterations can be made without consequential changes being necessary to specifications already agreed. All trademarks in this material are the property of the respective companies. Secop and the Secop logotype are trademarks of Secop GmbH. All rights reserved. www.secop.com